

MANUAL IXARC KIT ENCODERS WITH SSI INTERFACE



- Absolute singleturn and multiturn on one PCB
- Kit solution – no ball bearing, no tether, ultra compact: 22mm and 36 mm diameter
- Digital serial interface: SSI
- Electrical resolution: Up to 17 bit singleturn and 32 bit multiturn
- Operating temperature:
-40 to +105 °C / -40 to 221 °F
- Very robust, insensitive to dust or humidity
- Easy installation, no manual alignment due to electronic calibration, relaxed mechanical tolerances
- In comparison to resolvers, full digital interface, no signal processing on motor controller required, no additional expensive voltage generator needed
- Additional functionality like electronic datasheet (EDS), up to 4 Kbyte OEM memory
- Integrated temperature sensor on board
- Kit design includes shielding concept against external fields e.g. from magnetic brake

POSITAL

FRABA

MANUAL

IXARC KIT ENCODERS WITH SSI INTERFACE

Contents

Contact	4
Safety	5
1. Introduction	6
2. Electrical Data	7
2.1 Connector	7
2.2 Electrical Characteristics	7
2.3 Communication Parameters.....	8
3. SSI Interface	9
3.1 Transmission Protocol	9
3.1.1 SSI Transmission Frame	9
Type S10XB	10
Figure 2: Protocol structure S10xB	10
KCD-S10XB-1617-XXXX-XXX.....	10
KCD-S10XB-0017-XXXX-XXX.....	10
Type S30XB	11
KCD-S30XB-1617-XXXX-XXX.....	11
3.1.2 Register Communication	11
4. Configuration Interface (UBICOM).....	12
4.1 Message Format	12
4.2 Commands	13
5. Hardware and Software Features	14
5.1 Function Overview	14
5.2 Temperature Readout	15
5.3 Wiegand Sensor Test.....	16
5.4 Calibration	18
5.5 Data Storage	20
5.6 Filter Selection.....	21
5.7 Preset Function	22
5.8 Diagnostics	25
5.9 SSI Interface: Parameter Change.....	26
6. Plug & Play via USB	28
6.1 Kit Control Box.....	28
7. References	30
8. Appendix	30
8.1 Register Overview	30
8.1.1 Direct Registers	30

POSITAL

FRABA

MANUAL IXARC KIT ENCODERS WITH SSI INTERFACE

8.1.2 Special Encoder Functions.....	31
8.1.3 Special Encoder Functions 2.....	32
8.1.4 EDS Encoder Data.....	32

POSITAL

FRABA

MANUAL

IXARC KIT ENCODERS WITH SSI INTERFACE

Release Note

Version Date: 22.04.2021

Version Number: 1.3

Authors: MLA, DKI,

Reviewer: KMA, YTR, SHI

Valid for

IXARC Encoder Kit Type	Firmware version
KCD-S101B-1617-XXXX-XXX	≥ 1.2.0
KCD-S103B-xxxx-XXXF-XXX	≥ 1.6.0
KCD-S303B-xxxx-XXXF-XXX	≥ 1.6.0
KCD-S113B-xxxx-XXXF-XXX	≥ 1.12.0

User Annotation

Please note, that no responsibility is assumed by POSITAL for any consequences arising out of the use of this material. This document is not intended as an instruction manual for untrained people.

POSITAL welcomes all readers to send us feedback and comments about this document.

Contact

FRABA America

T +1 609 750-8705

▶ info@posital.com

FRABA Europe

T +49 221 96213-0

▶ info@posital.eu

FRABA Asia

T +65 6514 8880

▶ info@posital.sg

© FRABA B.V., All rights reserved. The company FRABA B.V. claims copyright on this documentation. It is not allowed to modify, to extend, to hand over to a third party and to copy this documentation without written approval by the company FRABA B.V.. Nor is any liability assumed for damages resulting from the use of the information contained herein. Further, this publication and features described herein are subject to change without notice. We do not assume responsibility for technical inaccuracies or omissions. Specifications are subject to change without notice.

MANUAL IXARC KIT ENCODERS WITH SSI INTERFACE

Safety

- The encoder must be installed by qualified personnel only, exhibiting knowledge in electronics and mechanics.
- Consider all safety and accident regulations valid for your country.
- Switch off the supply voltage of all devices connected to the encoder before installation.
- Avoid an electrical supply voltage while connecting the encoder.
- Avoid exerting shocks on motor shaft and mounting flange to prevent the encoder from being mechanically damaged.
- Rotary machine shafts may catch hair and cloths and cause injury.
- Mount the encoder in an ESD-conform fashion, avoid high voltages, e.g. static electricity discharged from a human body.
- Consider the specifications of the encoder. The device must be operated in the specified range.
- Metal filings or metal dust must be kept away from kit encoder parts and also during the assembly process.

MANUAL

IXARC KIT ENCODERS WITH SSI INTERFACE

1. Introduction

With a combination of accuracy, reliability, robustness and cost efficiency POSITAL's magnetic kit encoders provide a unique variety of functionalities. An electrical resolution of up to 17 bit offers an accurate singleturn measurement. The multiturn range covers more than one million revolutions. A large temperature range between -40 °C and +105 °C makes the kit encoders applicable in lots of environmental conditions. The kit encoder components include an electronics package mounted on a compact PCB and a small permanent magnet, designed to be mounted on the end of a motor shaft. The electronics package includes four Hall sensors, a powerful 32-bit microprocessor and a rotation counter based on POSITAL's Wiegand energy harvesting system. The SSI interface enables a direct digital sensor data transmission.

The multiturn counting is realized by POSITAL's energy harvesting system, based on the Wiegand effect. At any revolution, a voltage pulse is generated, which triggers the increment of an internal multiturn counter. This Wiegand pulse counting requires no external energy source. Therefore, a backup battery or complex gear systems can be eliminated.

In contrast to optical encoders, the installation of POSITAL's magnetic kit encoders requires no clean room similar conditions and can be performed under normal factory conditions. The integrated electronic autocalibration function corrects position errors due to minor misalignments between motor shaft and electronics package and makes a manual alignment procedure obsolete. In addition, a software integrated Wiegand pulse test determines the performance of the multiturn counter system. The kit encoder's embedded software monitors the system and provides associated error codes, that are transmitted during normal sensor operation. Furthermore, status and error information can be read out from the memory register.

In this manual, an overview of our SSI kit encoder is presented. The electrical connection and characteristics of the device is provided in [chapter 2](#). [Chapter 4](#) gives a description of the serial communication protocol UBICOM. The integrated hardware and software features of the kit encoder are described in [chapter 5](#).

MANUAL

IXARC KIT ENCODERS WITH SSI INTERFACE

2. Electrical Data

2.1 Connector

Ø 36mm KIT: BM08B-GHS-TBT (JST)

Ø 22mm KIT: BM08B-NSHSS-TBT (JST)

Pin No.	Symbol	Description
1 (blue)	GND	Ground reference voltage
2 (rose)	Preset	Preset trigger
3 (gray)	Config	Config via serial communication (UBICOM)
4 (green)	Data +	SSI Data +
5 (yellow)	Data -	SSI Data -
6 (white)	CLK -	SSI Clock -
7 (brown)	CLK +	SSI Clock +
8 (red)	VCC	Supply Voltage with respect to GND

Table 1: Main Connector Allocation.

2.2 Electrical Characteristics

Item No.	Parameter	Ø	Symbol	Min.	Typ.	Max.	Unit	Remark
201	Supply Voltage	36mm	VCC	4.75	5.0	15	V	@25 °C, DC, other voltages possible on request.
		22mm		4.5	5.0	5.5		
202	Power Consumption	36mm	PC		0.3		W	
		22mm			0.45			
203	Reverse Polarity Protection	36mm				-15	V	
		22mm				no		

Table 2: Kit Encoder Electrical Characteristics.

POSITAL

FRABA

MANUAL

IXARC KIT ENCODERS WITH SSI INTERFACE

2.3 Communication Parameters

The communication parameters are listed below

Item No.	Parameter	Symbol	Min.	Typ.	Max.	Unit	Remark
301	Serial Communication Format	SSI					-
302	Output Driver	RS-422					-
303	SSI structure	Multiturn (MT) Singleturn (ST)			16 bit 17 bit		Default. MSB first
305	Clock Frequency	CF	0.3		10	MHz	See Figure 2 / 3
306	Interface Cycle Time	CT	50			μs	With a cycle time of 50 μs, a clock frequency >= 1MHz must be used.
307	SSI Timeout	Tout			7	μs	See Figure 2 / 3
308	Start phase		8		64	bits	See Figure 2 / 3 and chapter 5.9

Table 3: SSI Communication Parameters.

MANUAL

IXARC KIT ENCODERS WITH SSI INTERFACE

3. SSI Interface

The SSI interface provides a communication connection between a master device, representing the motor control unit and its connected slave device, representing the kit encoder. The devices are connected in a point to point configuration, that only requires two unidirectional lines (clock and data) using differential signaling each. The slave device is synchronized by the clock signal, generated by the master. Therefore, it receives the transferred clocks and passes on its generated signal to the slave output line which is directly connected to the input line of the master (see [Figure 1](#) [Figure 4](#)).

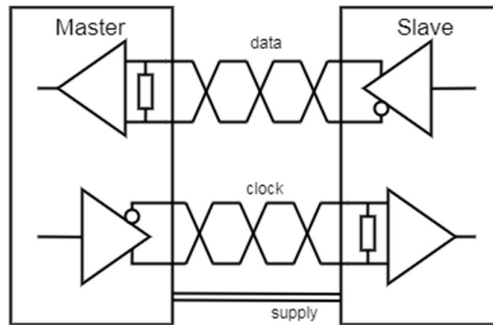

Figure 1: SSI interface.

3.1 Transmission Protocol

The communication between master and slave follows a defined pattern based on the SSI transmission frame (see [Figure 2](#) / [3](#)).

3.1.1 SSI Transmission Frame

Type	Start Phase	Position Value			
		MT	ST	D1	D2
S10xB	8 bit	16 bit	17 bit	-	-
S303B	8 bit	16 bit	17 bit	1 bit	1 bit

MANUAL

IXARC KIT ENCODERS WITH SSI INTERFACE

Type S10XB

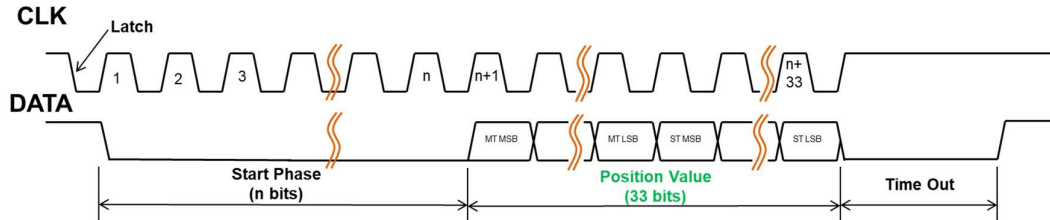

Figure 2: Protocol structure S10xB

KCD-S10XB-1617-XXXX-XXX

The SSI transmission frame is started and ended by the master clock signal (MA). The first falling edge of the MA latches the kit encoder position. With the first rising edge, the slave sets the data line to "0". The data line is "0" for the next 8 clocks. After this start phase the slave transmits the position data.

The position data consists of:

- Multiturn value (MT) 16 bit
- Singleturn value (ST) 17 bit

The MSB is transmitted first.

KCD-S10XB-0017-XXXX-XXX

The SSI transmission frame is started and ended by the master clock signal (MA). The first falling edge of the MA latches the kit encoder position. With the first rising edge, the slave sets the data line to "0". The data line is "0" for the next 8 clocks. After this start phase the slave transmits the position data.

The position data consists of:

- Singleturn value (ST) 17 bit

The MSB is transmitted first.

MANUAL

IXARC KIT ENCODERS WITH SSI INTERFACE

Type S30XB

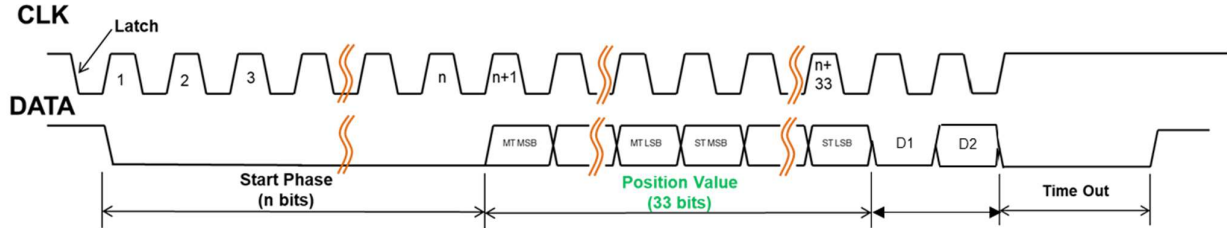

Figure 3: Protocol structure S303B

KCD-S30XB-1617-XXXX-XXX

The SSI transmission frame is started and ended by the master clock signal (MA). The first falling edge of the MA latches the kit encoder position. With the first rising edge, the slave sets the data line to "0". The data line is "0" for the next 8 clocks. After this start phase the slave transmits the position data.

The position data consists of:

- Multiturn value (MT) 16 bit
- Singleturn value (ST) 17 bit
- D1: constant value "0" (1 bit)
- D2: Error Bit for indication of sensor internal status Value = "1": no error, Value = "0": error (1 bit)

The MSB is transmitted first.

3.1.2 Register Communication

By using register communication, the slave registers can be accessed. This allows the execution of the sensor calibration, the Wiegand sensor test and the query of status and device information. Therefore, the slave registers are accessed with their corresponding addresses. To establish a register communication with the kit encoder (slave) is to build up serial communication via the config pin using the UBICOM protocol. For the definition and further details on the UBICOM protocol see chapter 4.

POSITAL

FRABA

MANUAL

IXARC KIT ENCODERS WITH SSI INTERFACE

4. Configuration Interface (UBICOM)

The UBICOM protocol defines a simple protocol over the UART Interface. The Interface is used in half-duplex master slave mode. The slave (encoder) does only answer on request. Hardware connection with the encoder is made on the config pin.

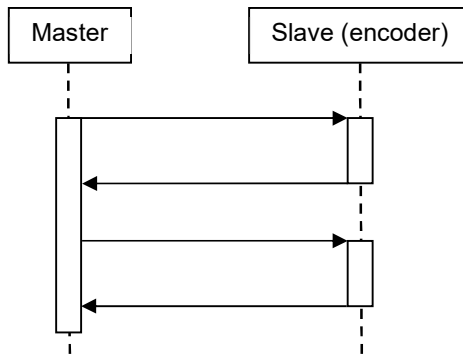

Figure 4: Transmission diagram.

4.1 Message Format

The data is sent with 115200 Baud in 8N1 over the UART port (RS232 TTL level).

Header				Payload	Checksum
Sync	Address	Command	LEN		
0x80	<node>	<cmd>	LSB><MSB><	<data_0>... <data_n>	<chk>

SYNC	Start of frame is always 0x80.
Address	0x01
Command	See description below
LEN	Length of Data (only the Data content count)
Payload	Depends on command. See description
Checksum	The checksum is calculated over all bytes and then inverted. Example: NOT(0x80+0x01+0x01+0x02+0x00+0x00) = NOT(0x84) = 0x7B

Table 4: UBICOM definitions.

MANUAL

IXARC KIT ENCODERS WITH SSI INTERFACE

4.2 Commands

Read parameter

Get status information from the Slave. This is also used to determine if a programming cycle has completed.

Command	Name	LEN	Payload
0x01	Read parameter	0x02	<Register number>

Table 5: Command read message (Master -> Slave)

The DUT replies with a status message:

Command	Name	LEN	Payload
0x01	Read parameter	0x01	<Register content>

Table 6: Command read response (Slave -> Master)

Write parameter

Get status information from the slave. This is also used to determine if a programming cycle has completed.

Command	Name	LEN	Payload
0x02	Write parameter	0x03	<Register number><Data>

Table 7: Command write message (Master -> Slave)

The DUT replies with a status message:

Command	Name	LEN	Payload
0x02	Write parameter	0x01	<Status>

Table 8: Command write response (Slave -> Master)

The status is DATA_ACK==0x90 or DATA_NAK==0xA0.

Get position word

Command	Name	LEN	Payload
0x03	Get position word	0x01	0x01

Table 9: Command get position (Master -> Slave)

The slave replies with the position word. The data is transmitted LSB first.

The position data has a length of 33 bit with 16 bit MT and 17 bit ST.

Command	Name	LEN	Payload
0x03	Get position word	0x05	<LSB> Position word <MSB>

Table 10: Command get position response (Slave -> Master)

Note, the use of the UBICOM protocol via the config pin is valid from firmware version 1.2.0.

MANUAL

IXARC KIT ENCODERS WITH SSI INTERFACE

5. Hardware and Software Features

5.1 Function Overview

The SSI kit encoder provides a set of additional features aside the actual angle measurement:

- Temperature Readout
- Wiegand Sensor Test
- Singleturn Calibration
- OEM Data Storage
- Filter Selection
- Electronic Datasheets
- Preset Function
- Diagnostics
- Interface Parameter Change

The features can be run directly via the config pin using the UBICOM protocol. For the serial communication, there is a hardware and software available for direct application. For more details see chapter 6.

The activation of a feature requires the activation of the corresponding device mode, except for the temperature readout. The change of the device mode is password secured. To enable the device mode configuration, the password "0x2A" must be written to register 0x6B. Next, the desired register value is written to the device mode register 0x6A.

Command Register	Register Address (direct)
Password register (password: 0x2A)	0x6B
Device mode register	0x6A

The following device modes are available:

Device Mode	Register Value
Operation mode	0x00
Calibration mode	0x01
Wiegand Sensor Test mode	0x02
OEM/EDS Motor Data Write	0x04
Filter Selection mode	0x05
Preset mode	0x07
Interface Parameter Change	0x08

MANUAL

IXARC KIT ENCODERS WITH SSI INTERFACE

Note

- All listed device features perform write cycles in the flash memory. Due to flash endurance, 1000 write cycles should not be exceeded.
- The device must be set back to operation mode, after carrying out a feature! The password register is not reset by changing the mode back to operation mode.

5.2 Temperature Readout

The SSI kit encoder has an internal temperature sensor, used to monitor the encoder temperature. The measured temperature value T_{reg} is stored in the register 0x66. The register value T_{reg} can be converted to °C with equation

$$T[°C] = T_{reg} - 50$$

and to °F with equation:

$$T[°F] = 1.8 * T_{reg} + 32$$

The specifications of the integrated temperature sensor can be found in [Table 11](#)~~Table-11~~. A change of the device mode is not necessary for this encoder feature.

Attention: The sensor measures the encoder temperature and is not intended to substitute a motor temperature sensor!

No.	Register Address	Value	OP	Remark
1	0x66	T_{reg}	R	Read out temperature register.

Parameter	Symbol	Remark
Interface	TSI	UART, size: 8 bit
Temperature Accuracy	TSA	5 °C
Temperature Range	TSR	-40 to 130 °C

Table 11: Temperature Sensor Properties.

POSITAL

FRABA

MANUAL

IXARC KIT ENCODERS WITH SSI INTERFACE

5.3 Wiegand Sensor Test

The SSI kit encoder uses a magnetic Wiegand counter to provide absolute multiturn values. The software integrated Wiegand sensor test measures the Wiegand sensor properties, by analyzing Wiegand pulses for 515 motor shaft revolutions. The test must be carried out for both clockwise (CW) and counterclockwise (CCW) rotations and is performed by the following sequence. Carry out the sequence for CW first and afterwards for CCW direction.

No.	Register Address	Value	OP	Remark
1	-	-	-	Run the motor at constant rotation speed in CW direction. A rotation speed of 500-2000 rpm is recommended.
2	0x2B	0x2A	W	Enable device mode configuration: Write password 0x2A to register.
3	0x2A	0x02	W	Change device mode to Wiegand sensor test mode.
4	0x46	0x01	W	Start Wiegand sensor test, CW direction. The duration of the test routine depends on the rotation speed of the motor. The test must run for at least 515 motor revolutions.
5	0x47		R	Check the result of the test by reading the Wiegand sensor test status register. If the pulse collection in CW direction is active, the register value is 0x01. If the pulse collection in CW direction is finished, the routine waits for the change of motor direction to CCW (value 0x03).
6	-	-	-	Run the motor in CCW direction.
7	0x46	0x02	W	Start Wiegand sensor test, CCW direction.
8	0x47		R	Check the result of the test by reading the Wiegand sensor test status register. If the pulse collection in CCW direction is active, the register value is 0x04. If the pulse collection in CCW direction is finished, the test is completed (value 0x06).
9	0x46	0x05	W	Save the acquired result data permanently. The saved data is not visible until an encoder reboot.
10	0x46	0x03	W	Finish test.
11	0x2A	0x00	W	Change device mode back to operation mode.

The saved result data can be checked at any time if step 9 was executed. The average pulse height of the analyzed pulses and its standard deviation is saved for CW and CCW direction. A Wiegand pulse height average minus 4x standard deviation greater than 5.3 V is recommended for operation.

POSITAL

FRABA

MANUAL

IXARC KIT ENCODERS WITH SSI INTERFACE

Wiegand Sensor Test Status Register	Register Value
Test stopped	0x00
Pulse Collection active (CW)	0x01
Wait for change of motor rotation direction	0x03
Wrong motor rotation direction	0x30
Pulse Collection active (CCW)	0x04
Test complete	0x06
Test failed	0x07

Result Data (last test)	Register Address
Average Pulses (CW)	0x49
Average minus 4x Standard Deviation (CW)	0x4A
Average Pulses (CCW)	0x4B
Average minus 4x Standard Deviation (CCW)	0x4C

Result Data (saved)	Register Address
Average Pulses (CW)	0x51
Average minus 4x Standard Deviation (CW)	0x52
Average Pulses (CCW)	0x53
Average minus 4x Standard Deviation (CCW)	0x54

Note

- The result data values must be divided by 10 to get the value in volts.
- The Wiegand sensor test can be stopped at any time by writing value 0x03 to the pulse testing command register.
- The measured pulses are not depended on rotation speed, but low rotation speeds can lead to long test times.

Attention

- The encoder cannot be used as a feedback system during the test!
- It is mandatory to run the Wiegand sensor test once after installation is finished.
- The encoder is not able to identify the rotation direction of the motor during the test, so make sure rotation and test direction match.

MANUAL

IXARC KIT ENCODERS WITH SSI INTERFACE

5.4 Calibration

The electronic calibration of the SSI encoder is required to improve the measurement accuracy of the kit encoder after installation.

The device is delivered in a pre-calibrated state. In factory state the accuracy of the encoder after installation the 22mm version is limited to an angle error below $\pm 0.5^\circ$ typically, the 36mm version is limited to an angle error below $\pm 0.3^\circ$ typically. This is caused by mechanical tolerances during the mounting of the kit encoder onto the motor shaft (static or build-up tolerances). By using the offered electronic calibration procedure, the impact of the static mounting tolerances on the kit encoder accuracy can be cancelled out and the system angle error will be improved towards the specified accuracy. Existing calibration is not lost when starting new calibration.

Please note, that after the electronic calibration further movements of the mounted magnet on the shaft towards the kit encoder (due to dynamic tolerances e.g. thermal expansion of the shaft or play of the ball bearing) should be minimized as these tolerances have a negative impact on the total system accuracy. For specific static and dynamic tolerance values refer to the datasheet of the corresponding Kit encoder.

External Conditions for Calibration

To successfully calibrate the SSI kit encoder several external conditions must be fulfilled. The sensor must be completely mounted (including top shield for magnetic shielding) and fixed in the final position before the calibration is started. All external conditions should match the normal operation conditions as far as possible. The operating temperature of the kit encoder must be in the range of 25 °C to 40 °C (77 °F to 104 °F).

Calibration Register	Register Address
Command register	0x40
Status register	0x41

Calibration Status Register	Register Value
Calibration running	0x01
Calibration finished (CCW)	0x02
Calibration finished (CW)	0x22
Wrong rotation direction	0x30
Temperature out of range	0x31
Motor speed out of range	0x32
Calibration failure	0x33

POSITAL

FRABA

MANUAL

IXARC KIT ENCODERS WITH SSI INTERFACE

Calibration Procedure

Description of recommended motor speed settings:

- Applicable speed range for
 - 36 mm kit between 300 rpm and 700 rpm
 - 22 mm kit between 300 rpm and 1200 rpm
- Assure synchronized speed with max. fluctuation of ± 2 rpm
- Recommended motor speed = 500rpm, synchronized speed ± 2 rpm

Note:

- resulting angular accuracy is directly dependent on the rotational speed uniformity
- filter setting V3B (default) has to be active, when calibration is performed

The calibration procedure is performed by carrying out the following sequence:

VIDEO INSTRUCTION

No.	Register Address	Value	OP	Remark
1	-	-	-	Run the motor in CCW direction at constant rotation speed of 500 rpm $< \pm 2$ rpm.
2	0x2B	0x2A	W	Unlock device mode configuration: Write password 0x2A to register.
3	0x2A	0x01	W	Change the device mode to calibration mode.
4	0x40	0x01	W	Start the calibration routine, CCW direction: Write value 0x01 to the calibration command register. The execution of the calibration routine takes about 5 seconds and stops automatically.
5	0x41		R	Read the calibration status until the register value is 0x02, then the calibration in CCW direction is finished. Note that while the encoder is performing the calibration, it may not respond.
6	-	-	-	Run the motor in CW direction.
7	0x40	0x02	W	Start the calibration routine, CW direction: Write value 0x02 to the calibration command register.
8	0x41		R	Read the calibration status register until the register value is 0x22, then the calibration in CW direction is finished. The calibration data is saved automatically.
9	0x2A	0x00	W	Change the device mode back to operation mode.

Note, that If calibration fails in CW direction the calibration table is lost, which leads to an increase of the angle error.

Attention: The encoder cannot be used as a feedback system during calibration!

MANUAL

IXARC KIT ENCODERS WITH SSI INTERFACE

5.5 Data Storage

The SSI encoder offers the capability to access two different internal memory regions to store data: The EDS-Motor-Data and the OEM-Data. The corresponding memory addresses are given in table 2. The accessibility of the specific memory depends on the access rights.

Memory	Start-Addr.	End-Addr.	Access	Remark
EDS En-coder Data	0xC0	0x13F	R	We support the BiSS Profile 3 as Standard Encoder Profile.
EDS-Motor-Data	0x140	0x93F	R/W	2 Kbyte Motor Data: customer specific motor data
OEM-Data	0x940	0x113F	R/W	2 Kbyte OEM Memory: open access for customer use

Table 12: Data Storage Overview.

Writing the EDS-Motor-Data or OEM-Data is permitted by default. The write access is protected by a password. To write an EDS-Motor or OEM-Data register, carry out the following sequence:

No.	Register Address	Value	OP	Remark
1	0x2B	0x2A	W	Unlock device mode configuration: Write password 0x2A to register.
2	0x2A	0x04	W	Change the device mode to OEM / EDS Motor Data Write.
3	0x5B		R	Get write access: Read OEM / EDS-Motor Data Write status register until a value of 0x00 indicates permission to get write access to the EDS-Motor Data.
4	0x5A	0x01 or 0x02	W	Write the value to the OEM / EDS-Motor Data Write command register. 0x01: access EDS-Motor Data 0x02: access OEM-Data
5			W	Write data to the desired registers.
6	0x5B		R	Get save access: Read the OEM / EDS-Motor Data Write status register until a value of 0x01 indicates permission to get save access to the EDS-Motor Data.
7	0x5A	0x03	W	Write data to flash memory: Write the value 0x03 to the OEM / EDS-Motor Data Write command register
8	0x5A	0x04	W	(Optional) Cancel write access: Write the value 0x04 to the OEM / EDS-Motor Data Write command register.
9	0x2A	0x00	W	Change the device mode back to operation mode.

MANUAL

IXARC KIT ENCODERS WITH SSI INTERFACE

OEM / EDS-Motor Data Register	Register Address
Command register	0x5A
Status register	0x5B

OEM / EDS-Motor Data Command Register	Register Value
Get write access EDS-Motor Data	0x01
Get write access OEM-Data	0x02
Save data	0x03
Cancel write access	0x04

OEM / EDS-Motor Data Status Register	Register Value
Wait for write access	0x00
Wait for save command	0x01

Attention: Reading and writing data during motor operation is not allowed.

5.6 Filter Selection

The SSI encoder offers two different filter options:

- **Balanced (default)**
This filter provides a very well-balanced relation of signal noise and dynamic behavior.
- **Dynamic**
This filter provides position values with short latency, but increased signal noise. Therefore, this filter is suitable for very fast and dynamic motor control loops.

To check which filter is currently active, read direct register 0x6E (balanced: 0x03, dynamic: 0x04). To activate a filter setting, carry out the following sequence:

No.	Register Address	Value	OP	Remark
1	0x2B		W	Enable device mode configuration: Write password 0x2A to register.
2	0x2A	0x05	W	Change device mode to filter selection mode.
3	0x65		R	Get write access: Read filter status register. A value of 0x00 indicates permission to get write access.
4	0x64	0x01	W	Write value 0x01 to the filter command register.
5	0x65		R	Read filter status register. A value of 0x02 indicates waiting for value.

POSITAL

FRABA

MANUAL

IXARC KIT ENCODERS WITH SSI INTERFACE

6	0x64		W	Set filter: <ul style="list-style-type: none"> ▪ Balanced filter, value 0x03 ▪ Dynamic filter, value 0x04
7	0x65		R	Save filter selection: Read filter status register. A value of 0x01 indicates permission to save filter settings.
8	0x64	0x02	W	Write value to filter command register. Encoder reboots with new filter setting.
9	0x2A	0x00	W	Change the device mode back to operation mode.

Filter Selection Register	Register Address
Command register	0x64
Status register	0x65

Filter Selection Commands Register	Register Value
Get write access	0x01
Save filter selection	0x02
Balanced filter	0x03
Dynamic filter	0x04

Attention: The encoder cannot be used as a feedback system during the filter change!

Note, that the filter selection feature is only supported from firmware version 1.1.0.

5.7 Preset Function

The preset function can be used to adapt the encoder position to the mechanical alignment of the system. By performing a preset, the actual position value of the encoder is set to the desired preset value. The preset value is specified in registers 0x82 to 0x87. In registers 0x82 to 0x84 the singleturn preset value is saved in little-endian format. In registers 0x85 to 0x87 the multiturn preset value is saved in little-endian format. The preset can be triggered via hardware or software.

Preset Value	Singleturn preset value			Multiturn preset value		
Register Address	0x82	0x83	0x84	0x85	0x86	0x87
Endianness	LSB		MSB	LSB		MSB

Table 13: Preset value register.

POSITAL

FRABA

MANUAL

IXARC KIT ENCODERS WITH SSI INTERFACE

Hardware preset

The hardware preset performs a ST + MT preset by default. To perform a preset, the voltage level at the preset pin has to be pulled to V_{preset} and hold for at least $t_{\text{min}} = 100 \text{ ms}$ (see [Table 14](#) ~~Table-14~~, see 5). The manufacturer preset value is 0 by default. After t_{min} the preset value is overtaken independent of a longer high level on the input channel and the kit encoder is conducting a reset.

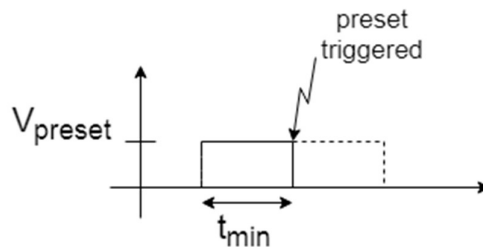

Figure 5: Preset hardware trigger.

Software preset

To change the preset value and perform a preset via software, follow the steps below:

No.	Register Address	Value	OP	Remark
1	0x2B	0x2A	W	Enable device mode configuration: Write password 0x2A to register.
2	0x2A	0x07	W	Change device mode to preset mode.
				To set the target preset value or configure the hardware preset, continue with step 3. To directly perform a preset, continue with step 10.
3	0x80	0x02	W	Enable preset value edit.
4	0,81		R	Read status register, a value of 0x01 indicates waiting for value to enter.
5	0x82 – 0x84		W	Enter singleturn preset value.
6	0x85 – 0x87		W	Enter multiturn preset value.
7	0x88	0x01 0x02 0x03	W	Enter hardware preset configuration. <ul style="list-style-type: none"> ▪ ST + MT, 0x01 (Default) ▪ ST, 0x02 ▪ MT, 0x03
8	0x80	0x03	W	Save preset value. Encoder restarts.
9				Repeat steps 1, 2, 3 to enter preset mode again.
10	0x80	0x01 0x04 0x05	W	Perform preset: <ul style="list-style-type: none"> ▪ ST + MT, 0x01 ▪ ST, 0x04 ▪ MT, 0x05 Encoder restarts with preset value.

POSITAL

FRABA

MANUAL

IXARC KIT ENCODERS WITH SSI INTERFACE

Example

Assuming it is desired to preset the singleturn position of a kit encoder with 17 bit singleturn resolution.

Desired singleturn position: 270°
 Corresponding decimal value in digits: 98304
 Expressed as a hex value: 0x18000

For this configuration, the register entries must be set as followed:

Register Address	0x82	0x83	0x84
Register Value	0x00	0x80	0x01

Preset Registers	Register Address
Command register	0x80
Status register	0x81
Singleturn preset value	0x82 – 0x84
Multiturn preset value	0x85 – 0x87
Hardware preset configuration register	0x88

Preset Command Register	Register Value
Perform preset	0x01
Enable preset value edit	0x02
Save preset value	0x03

Hardware Preset Configuration	Register Value
ST + MT (Default)	0x01
ST	0x02
MT	0x03

Note, that the preset function is only supported with KCD-S101B-1617-XXXX-XXX from firmware version 1.2.0.

The commands “Perform preset (ST)” and “Perform preset (MT)” are supported with KCD-S103B-XXXX-XXXX-XXX corresponding to firmware version 1.6.0.

The Hardware preset configuration is supported with KCD-SX13B-XXXX-XXXX-XXX from firmware version 1.12.0.

MANUAL

IXARC KIT ENCODERS WITH SSI INTERFACE

Item No.	Parameter	Symbol	Min.	Typ.	Max.	Unit	Remark
401	Preset voltage	V_{preset}	3.3		VCC	V	-
402	Preset low voltage level				1.2	V	-
403	Preset hold time	t_{min}	100			ms	-
404	Preset value			0			-

Table 14: Preset parameter table.

5.8 Diagnostics

The encoder has various errors and warning states, which can be read via registers. In any error case the SSI Interface will turn off, the data signal is logical "1" and communication will only be possible via UBIKOM.

Error Register (1 Byte)

Error Bit	Description	Comment
0	FRAM Error	Error detected in FRAM
1	Multiturn Error	Synchronization error
2	Singleturn Error	Position sensor error (e.g. voltage dump)
3	Temperature Sensor Fault	Temperature sensor error
4	Magnetic Field too low	e.g. detect missing magnet
5-7	Not used	-

Warning Register (1 Byte)

Warning Bit	Description	Comment
0	Temperature too high	Set at $T \geq 125^{\circ}\text{C}$, clear warning at $T < 123^{\circ}\text{C}$
1-7	Not used	-

The register addresses are defined in the register tables (appendix).

Note

- Diagnostic functions are supported starting with KCD-S103B-1617-XXXX-XXX, corresponding to firmware version 1.6.0.

MANUAL

IXARC KIT ENCODERS WITH SSI INTERFACE

5.9 SSI Interface: Parameter Change

Within this device mode interface parameters can be adjusted by the user.

5.9.1 Pre-Byte Parameter

The encoder needs a certain calculation time internally for a position request (comparable to the min. busytime in BiSS-C), which must not be underrun. Therefore, Pre-Bytes must be sent before sending data (see Figure 3Figure 3).

If the clock frequency is increased, the time available for calculations decreases. Therefore, the number of sent Pre-Bytes must be adjusted. Table 15 shows the step sizes provided for this purpose.

Parameter: Pre-Byte	Pre-Clocks	Max. Clock Frequency
1	8	1.33 MHz
2	16	2.67 MHz
3	24	4.00 MHz
4	32	5.33 MHz
5	40	6.67 MHz
6	48	8.00 MHz
7	56	9.33 MHz
8	64	10.00 MHz

Table 15: Pre-Byte Parameter.

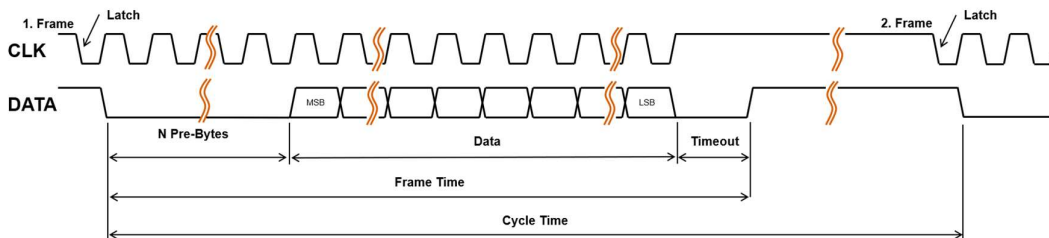

Figure 3: SSI Frame.

POSITAL

FRABA

MANUAL

IXARC KIT ENCODERS WITH SSI INTERFACE

The Pre-Byte parameter can be adjusted via encoder register by carrying out the following sequence:

No.	Register Address	Value	OP	Remark
1	0x2B	0x2A	W	Enable device mode configuration: Write password 0x2A to register.
2	0x2A	0x08	W	Change device mode to interface parameter change mode.
3	0x65		R	Read status register. 0x00 indicates permission to get write access.
4	0x64	0x01	W	Get write access. Write value to command register.
5	0x65		R	Read status register. 0x02 indicates waiting for value.
6				Enter parameter values
	0x31	0x01..0x08	W	Enter number of Pre-Bytes parameter.
7	0x64	0x06	W	Check validity of input parameters. Write value to the command register.
8	0x65		R	Read status register. 0x01 indicates permission to save parameters. 0x05 indicates parameter out of range.
9	0x64	0x02	W	Save parameters. Write value to command register. Encoder reboots with new parameter settings.

Interface Parameter Change Registers	Register Address
Command register	0x64
Status register	0x65

Interface Parameter Register	Register Address
Pre-Byte register	0x31

Commands	Register Value
Get write access	0x01
Save parameters	0x02
Cancel	0x05
Check validity of input parameters	0x06

MANUAL

IXARC KIT ENCODERS WITH SSI INTERFACE

Status	Register Value
Permission to get write access	0x00
Permission to save parameters	0x01
Error	0x04
Parameter out of range	0x05

Attention: The encoder cannot be used as a feedback system during the parameter change!

Note, that the interface parameter change feature is only supported from KCD-SX1XB-XXXX-XXXX-XXX and firmware version 1.12.0.

6. Plug & Play via USB

For easy commissioning there is the option to connect the encoder to a PC and access, configure or calibrate the encoder.

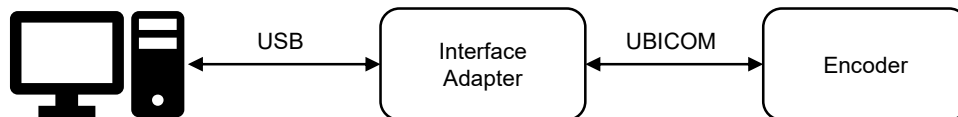

Figure 6: Connection of interface adapter.

6.1 Kit Control Box

Using UBICOM for communication

- Access position and register data
- Software GUI to run the main kit encoder functions
- Easy way to perform calibration, preset, Wiegand sensor test and configure filter settings
- Update firmware (available from firmware 1.6.0)
- Readout encoder temperature and firmware version
- Alternatively program your own encoder related requests based on the UBICOM protocol

Note

- In case Kit Control Box is used for configuration of KCD-S103B-XXXX-XXXF-XXX (Ø 22 mm), to prevent an encoder kit from electrical damage, please, ensure, that the control box has been produced not earlier than in 2020-05 and that the appropriate adapter cable is used. If an older version is available, please, contact us to arrange an update.

MANUAL

IXARC KIT ENCODERS WITH SSI INTERFACE

▶ VIDEO INSTRUCTION

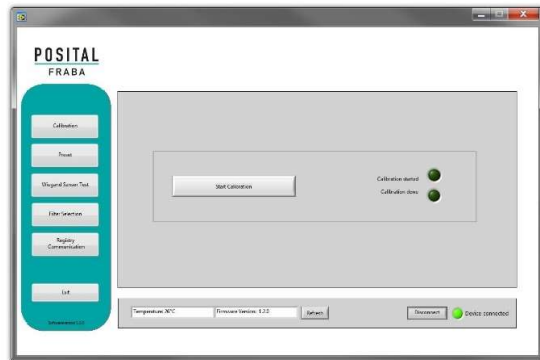

Figure 7: Kit Control Box and software GUI by POSITAL.

For more details see:

<https://www.posital.com/en/products/kit-encoders/kit-control-box.php>

MANUAL

IXARC KIT ENCODERS WITH SSI INTERFACE

7. References

8. Appendix

8.1 Register Overview

8.1.1 Direct Registers

Register Address	Description / Symbol	Access
0x04	Serial Number, U32	R
0x05		R
0x06		R
0x07		R
0x26	Temperature Intern	R
0x28	Fault Register	R
0x29	Warning Register	R
0x2A	Device Mode	R/W
0x2B	Protection	R/W
0x2E	Selected Filter	R
0x31	SSI Interface, Pre-Byte register	R/W
0x34	Major Firmware Release	R
0x35	Minor Firmware Release	R
0x36	Firmware Patch Level	R
0x38	Device ID	R
0x39		R
0x3A		R
0x3B		R
0x3C		R
0x3D		R
0x3E	Manufacturer Coder	R
0x3F		R

Table 16: Direct Registers.

MANUAL

IXARC KIT ENCODERS WITH SSI INTERFACE

8.1.2 Special Encoder Functions

Register Address	Description / Symbol	Access
0x40	Calibration Command	R/W
0x41	Calibration Status	R
0x46	Wiegand Sensor Test, Command Register	R/W
0x47	Wiegand Sensor Test, Status Register	R
0x48	Wiegand Sensor Test, Error Code	R
0x49	Wiegand Sensor Test, Average Pulses CW (last test result)	R
0x4A	Wiegand Sensor Test, Average minus 4x Standard Deviation CW (last test result)	R
0x4B	Wiegand Sensor Test, Average Pulses CCW (last test result)	R
0x4C	Wiegand Sensor Test, Average minus 4x Standard Deviation CCW (last test result)	R
0x4D	Wiegand Sensor Test, Average Pulses CW (FRABA Production)	R
0x4E	Wiegand Sensor Test, Average minus 4x Standard Deviation CW (FRABA Production)	R
0x4F	Wiegand Sensor Test, Average Pulses CCW (FRABA Production)	R
0x50	Wiegand Sensor Test, Average minus 4x Standard Deviation CCW (FRABA Production)	R
0x51	Wiegand Sensor Test, Average Pulses CW (saved test result)	R
0x52	Wiegand Sensor Test, Average minus 4x Standard Deviation CW (saved test result)	R
0x53	Wiegand Sensor Test, Average Pulses CCW (saved test result)	R
0x54	Wiegand Sensor Test, Average minus 4x Standard Deviation CCW (saved test result)	R
0x5A	OEM / EDS-Motor Data Write, Command Register	R/W
0x5B	OEM / EDS-Motor Data Write, Status Register	R
0x64	Filter Selection, Command Register	R/W
0x65	Filter Selection, Status Register	R

Table 17: Special Encoder Functions.

MANUAL

IXARC KIT ENCODERS WITH SSI INTERFACE

8.1.3 Special Encoder Functions 2

Register Address	Description / Symbol	Access
0x80	Preset Command	R/W
0x81	Preset Status	R
0x82	Preset singleturn value, byte 0	R/W
0x83	Preset singleturn value, byte 1	R/W
0x84	Preset singleturn value, byte 2	R/W
0x85	Preset multiturn value, byte 0	R/W
0x86	Preset multiturn value, byte 1	R/W
0x87	Preset multiturn value, byte 2	R/W
0x88	Preset hardware preset configuration	R/W

Table 18: Special Encoder Functions 2.

8.1.4 EDS Encoder Data

Register Address	Description / Symbol	Access
0x106	Maximum "power on delay" until position data is available	R
0x108	Encoder Type	R
0x10A	Data Length MULTITURN	R
0x10C	Data Length COARSE (Remark: SINGLETURN)	R
0x12C	Maximum revolution speed/maximum speed [1/min]	R
0x12D		R
0x130	Minimum operating temperature [K]	R
0x131		R
0x132	Maximum operating temperature [K]	R
0x133		R
0x134	Minimum operating voltage [mV]	R
0x135		R
0x136	Maximum operating voltage [mV]	R
0x137		R
0x138	Maximum current consumption [mA]	R
0x139		R

Table 19: / Electronic Data Sheet, Encoder Data.